

Assemble two congruent pieces of origami into a tetrahedron

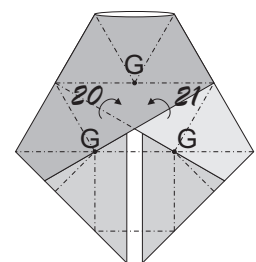

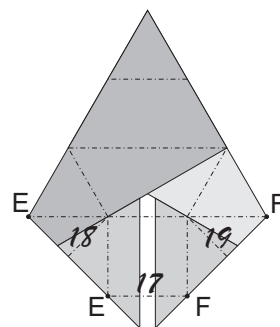

Half octahedron
Right pyramid with square base

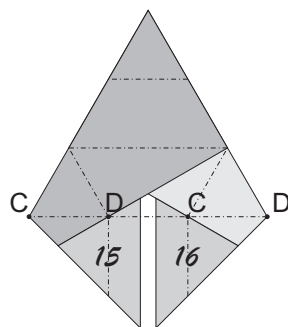
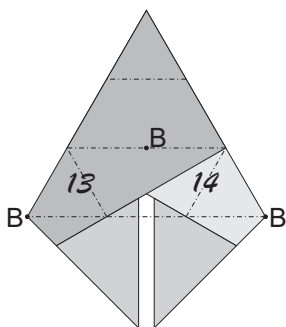
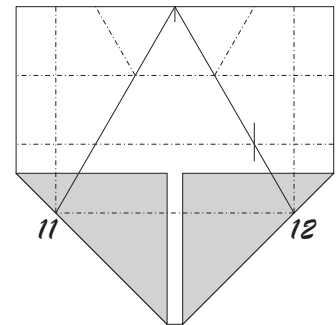
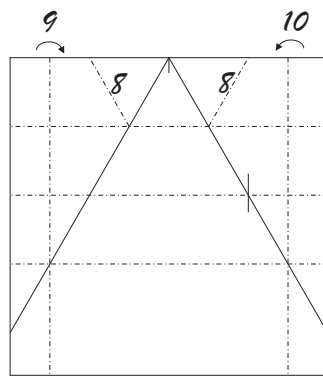
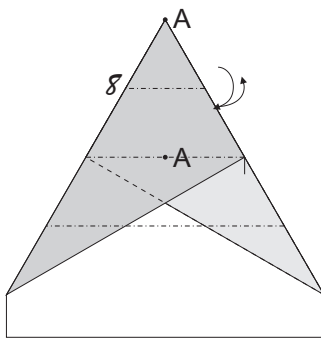
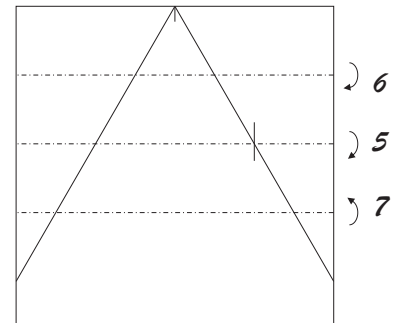
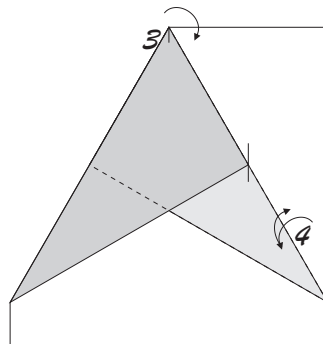
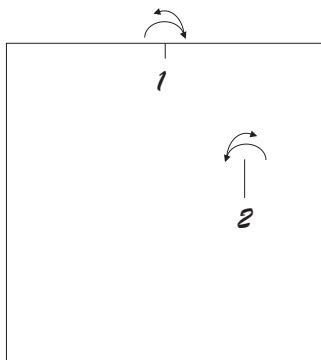
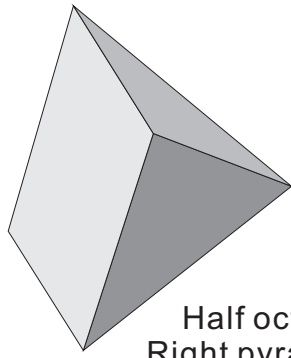
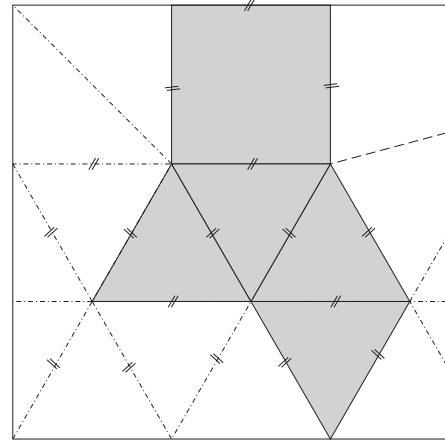

Folding the crease pattern

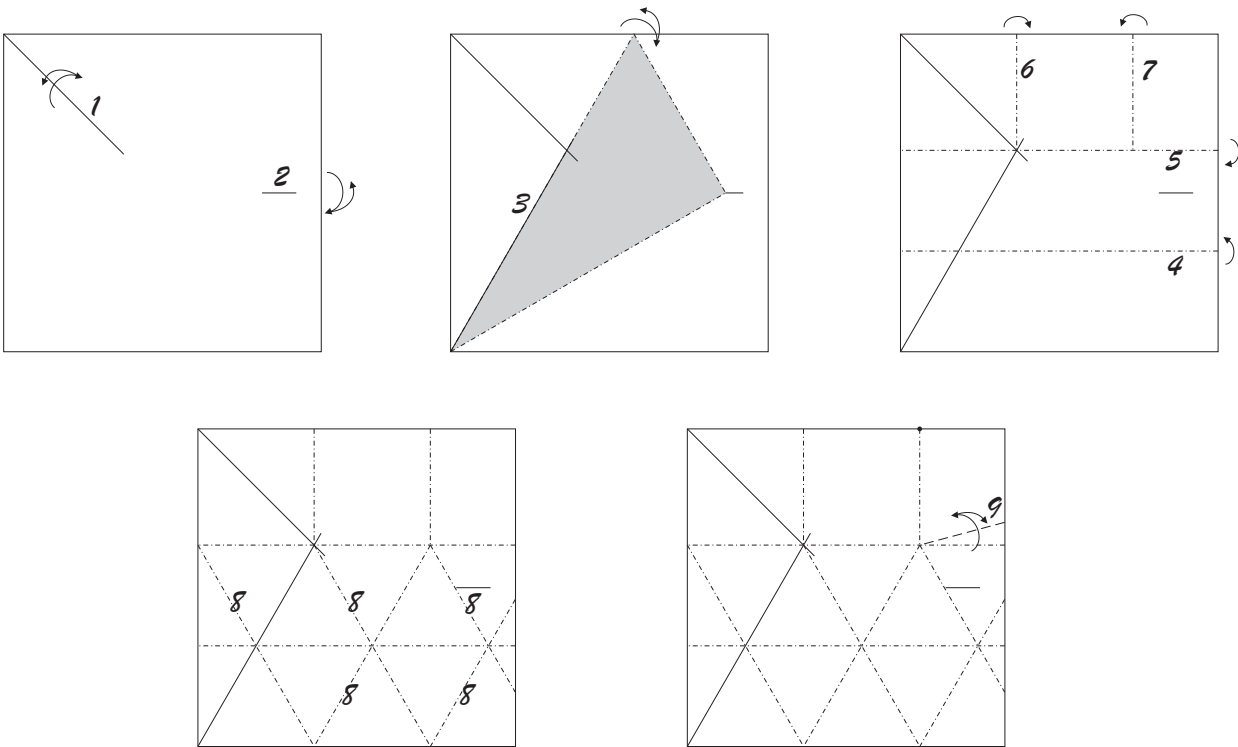

Folding into a 3D shape

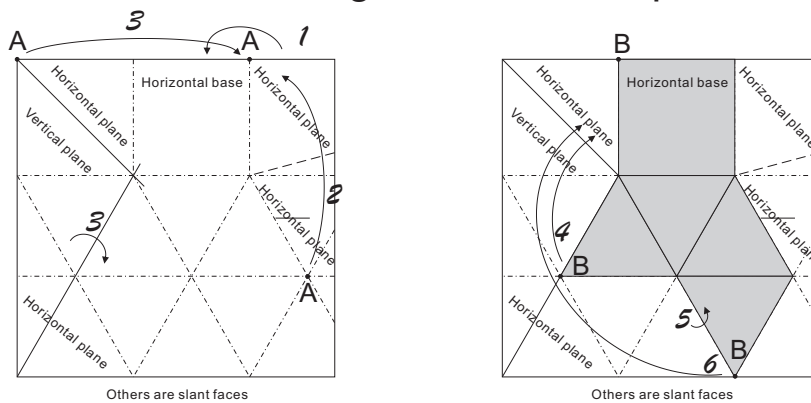

Others are slant faces

Others are slant faces

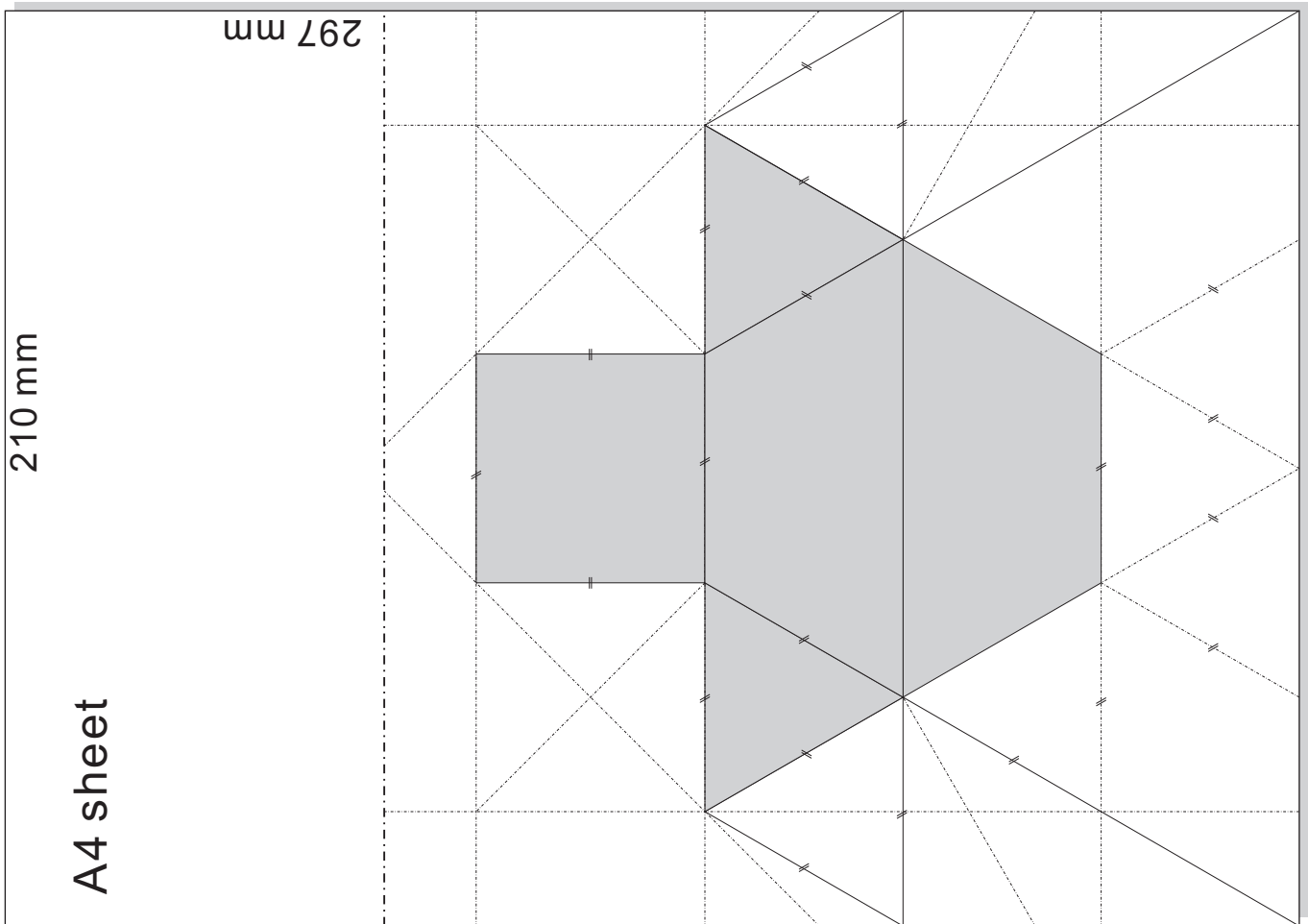
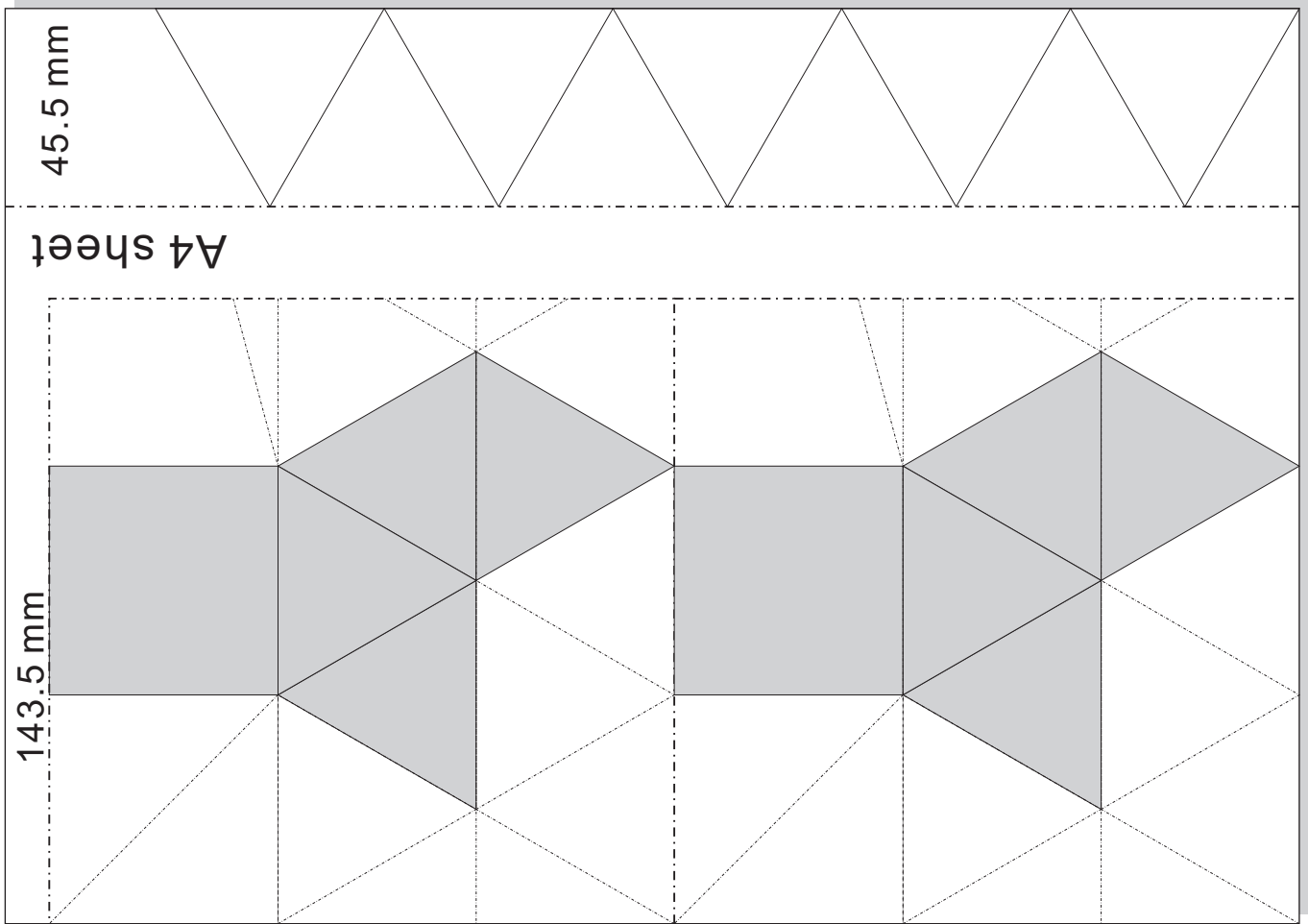

Moving lips

Trisecting an edge

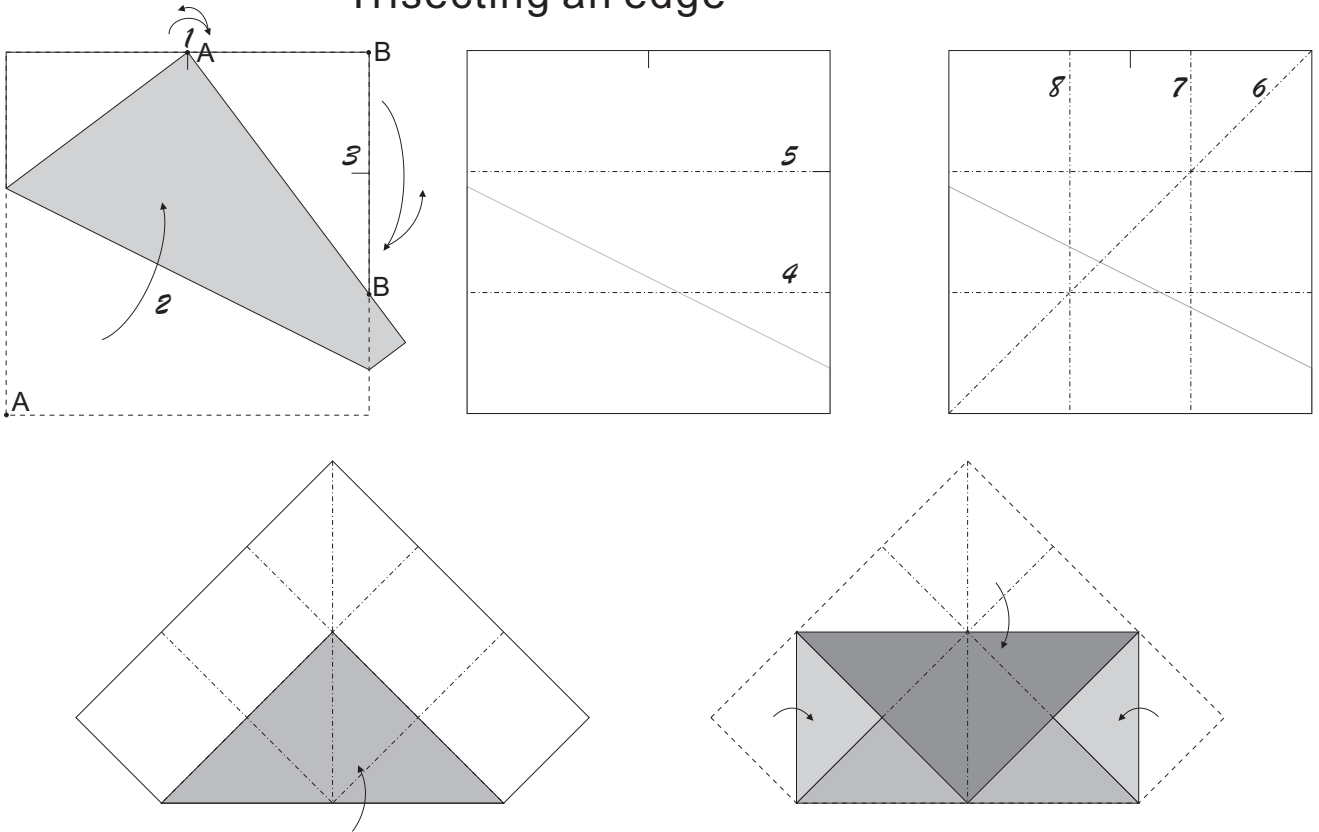

folding a moving beak

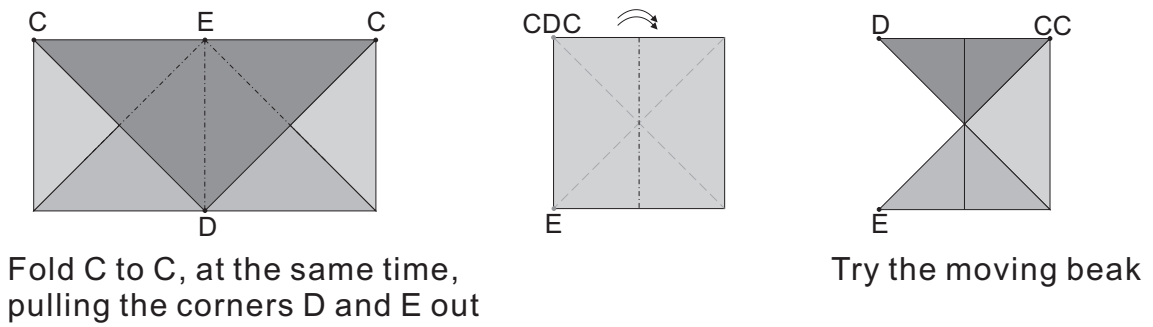

folding moving lips and finishing

